

RS3ABF THRU RS3MBF

Features

- For surface mounted applications
- Low profile package
- Glass Passivated Chip Junction
- Easy to pick and place
- Fast reverse recovery time
- Lead free in comply with EU RoHS 2011/65/EU directives

Mechanical Data

- Case: SMBF
- Terminals: Solderable per MIL-STD-750, Method 2026
- Approx. Weight: 57mg / 0.002oz

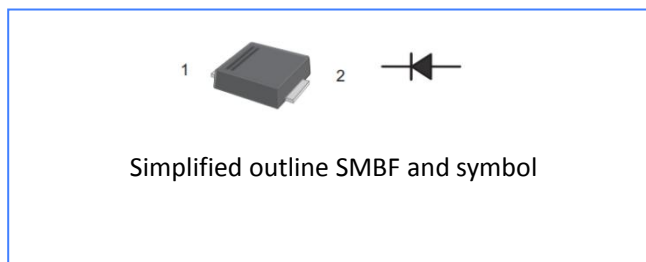

Pinning

PIN	DESCRIPTION
1	Cathode
2	Anode

Absolute Maximum Ratings And Characteristics

Ratings at 25°C ambient temperature unless otherwise specified.

Single phase, half wave, 60 Hz, resistive or inductive load. For capacitive load, derate current by 20%.

Parameter	Symbols	RS3ABF	RS3BBF	RS3DBF	RS3GBF	RS3JBF	RS3KBF	RS3MBF	Units
Maximum Repetitive Peak Reverse Voltage	V_{RRM}	50	100	200	400	600	800	1000	V
Maximum RMS voltage	V_{RMS}	35	70	140	280	420	560	700	V
Maximum DC Blocking Voltage	V_{DC}	50	100	200	400	600	800	1000	V
Maximum Average Forward Rectified Current at $T_c = 125^\circ\text{C}$	$I_{F(AV)}$	3							A
Peak Forward Surge Current 8.3 ms Single Half Sine Wave Superimposed on Rated Load	I_{FSM}	80							A
Maximum Forward Voltage at 1 A	V_F	1.3							V
Maximum DC Reverse Current $T_a = 25^\circ\text{C}$ at Rated DC Blocking Voltage $T_a = 125^\circ\text{C}$	I_R	5 100							μA
Typical Junction Capacitance at $V_R=4\text{V}$ $f=1\text{M}$	C_j	40							pF
Maximum Reverse Recovery Time ⁽¹⁾	t_{rr}	150				250	500		ns
Typical Thermal Resistance ⁽²⁾	$R_{\theta JA}$	45							$^\circ\text{C/W}$
	$R_{\theta JC}$	15							
Operating and Storage Temperature Range	T_j, T_{stg}	-55 ~ +150							$^\circ\text{C}$

(1) Measured with $I_F = 0.5\text{ A}$, $I_R = 1\text{ A}$, $I_{rr} = 0.25\text{ A}$

(2) .P.C.B. mounted with 2.0" X 2.0" (5 X 5 cm) copper pad areas.

Rating And Characteristic Curves

Fig.1 Maximum Average Forward Current Rating

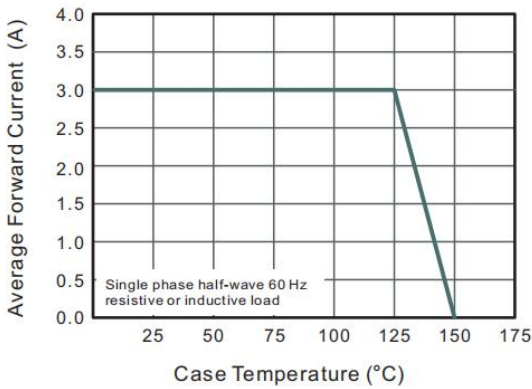

Fig.2 Typical Reverse Characteristics

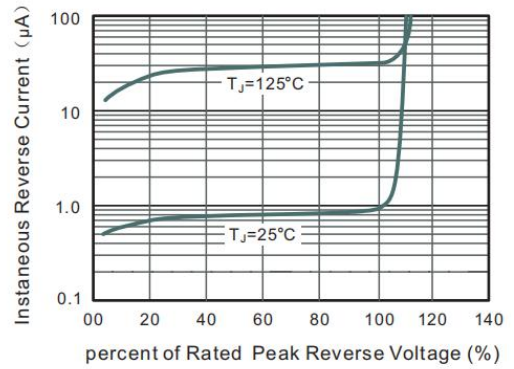

Fig.3 Typical Instantaneous Forward Characteristics

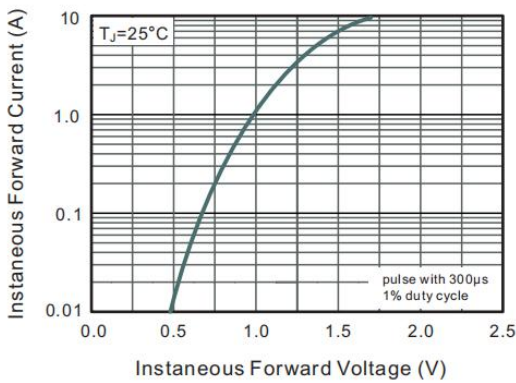

Fig.4 Typical Junction Capacitance

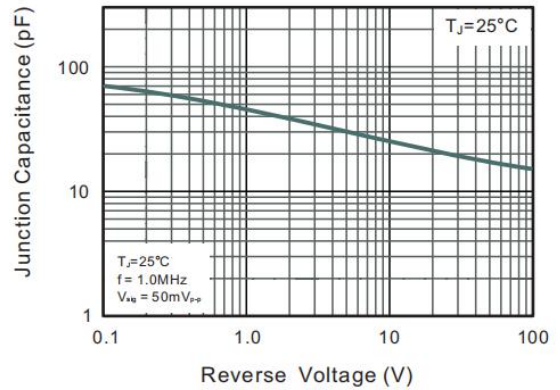
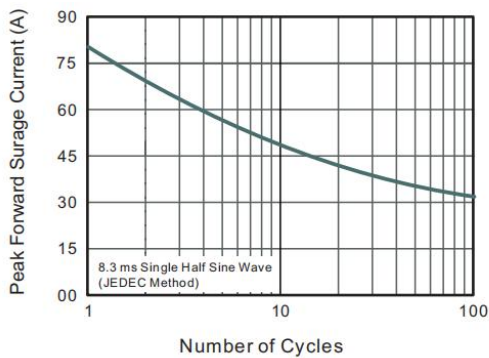

Fig.5 Maximum Non-Repetitive Peak Forward Surge Current



Package Outline

Plastic surface mounted package; 2 leads

SMBF

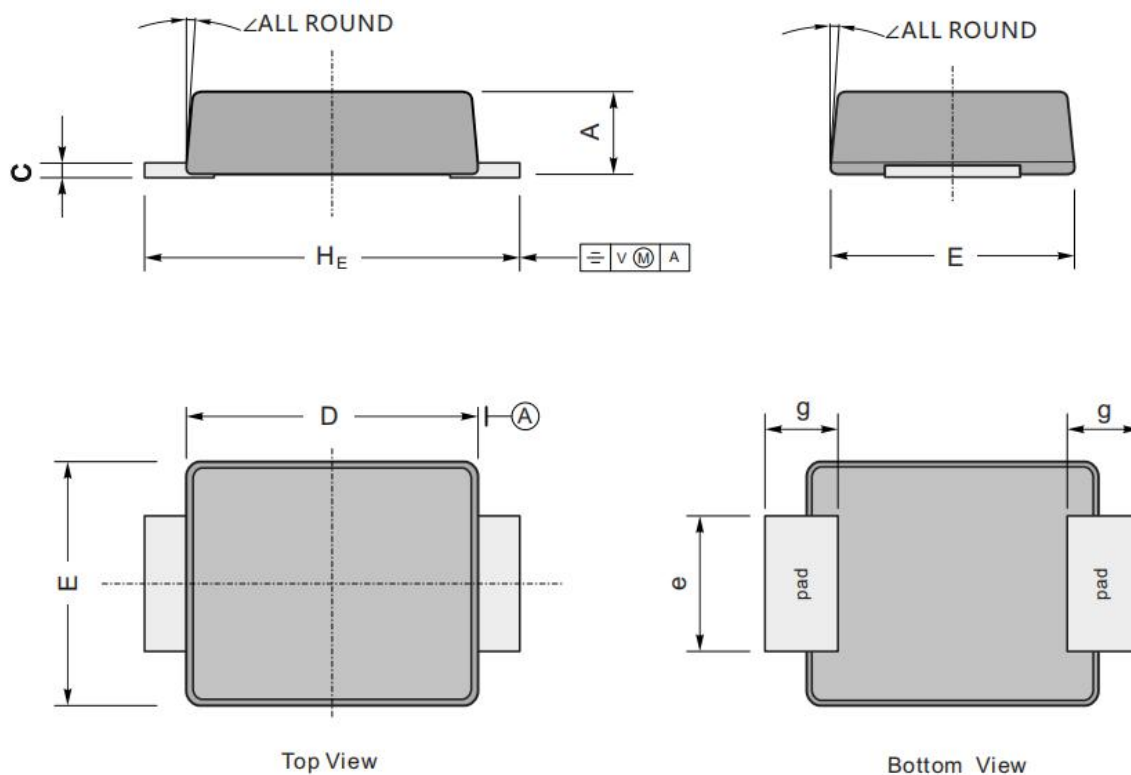

UNIT		A	C	D	E	e	H_E	g	\angle
mm	max	1.3	0.26	4.4	3.7	2.2	5.5	1.0	9°
	min	1.1	0.18	4.2	3.5	1.9	5.1		
mil	max	51	10	173	146	86	216	40	
	min	43	7	165	138	75	200		

The recommended mounting pad size

